

LM320L/LM79LXXAC Series 3-Terminal Negative Regulators

General Description

The LM320L/LM79LXXAC dual marked series of 3-terminal negative voltage regulators features fixed output voltages of $-5V$, $-12V$, and $-15V$ with output current capabilities in excess of $100mA$. These devices were designed using the latest computer techniques for optimizing the packaged IC thermal/electrical performance. The LM79LXXAC series, even when combined with a minimum output compensation capacitor of $0.1\mu F$, exhibits an excellent transient response, a maximum line regulation of $0.07\% V_O/V$, and a maximum load regulation of $0.01\% V_O/mA$.

The LM320L/LM79LXXAC series also includes, as self-protection circuitry: safe operating area circuitry for output transistor power dissipation limiting, a temperature independent short circuit current limit for peak output current limiting, and a thermal shutdown circuit to prevent excessive junction temperature. Although designed primarily as fixed voltage regulators, these devices may be combined with simple external circuitry for boosted and/or adjustable voltages and currents. The LM79LXXAC series is available in the 3-lead

TO-92 package, 8-lead SOIC package, and the 6-Bump micro SMD package. The LM320L series is available in the 3-lead TO-92 package.

For output voltage other than $-5V$, $-12V$ and $-15V$, the LM137L series provides an output voltage range from $1.2V$ to $47V$.

Features

- Preset output voltage error is less than $\pm 5\%$ overload, line and temperature
- Specified at an output current of $100mA$
- Easily compensated with a small $0.1\mu F$ output capacitor
- Internal short-circuit, thermal and safe operating area protection
- Easily adjustable to higher output voltages
- Maximum line regulation less than $0.07\% V_{OUT}/V$
- Maximum load regulation less than $0.01\% V_{OUT}/mA$
- See AN-1112 for micro SMD considerations

Typical Applications

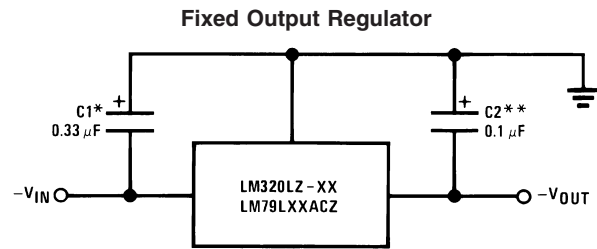

00774801

*Required if the regulator is located far from the power supply filter. A $1\mu F$ aluminum electrolytic may be substituted.

**Required for stability. A $1\mu F$ aluminum electrolytic may be substituted.

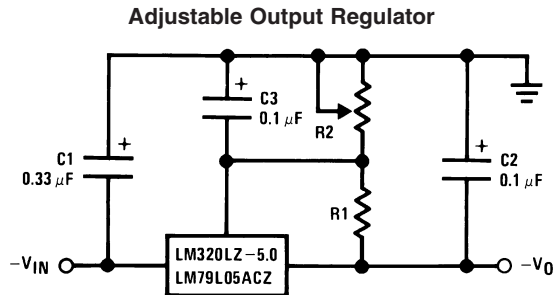

00774803

$$-V_0 = -5V - (5V/R1 + I_Q) \cdot R2$$

$$5V/R1 > 3 I_Q$$

Connection Diagrams

6-Bump micro SMD

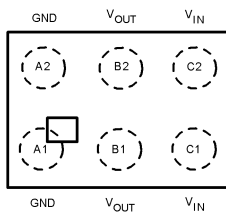

00774820

Bump Side Down

TO-92 Plastic Package (Z)

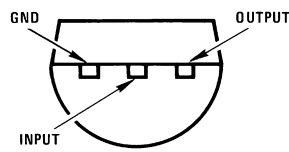

00774802

Bottom View

Connection Diagrams (Continued)

SO-8 Plastic (Narrow Body)

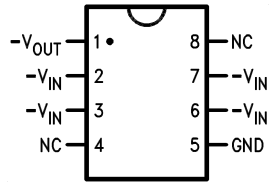

00774804

Top View

Ordering Information

Package	Part Number	Package Marking	Transport Media	NSC Drawing
8-Lead SOIC	LM79L05ACM	LM79L05ACM	95 Units/Rail	M08A
	LM79L05ACMX		2.5k Units Tape and Reel	
	LM79L12ACM	LM79L12ACM	95 Units/Rail	
	LM79L12ACMX		2.5k Units Tape and Reel	
	LM79L15ACM	LM79L15ACM	95 Units/Rail	
	LM79L15ACMX		2.5k Units Tape and Reel	
3-Pin TO-92	LM79L05ACZ	320L79L05	1800 Units Per Box	Z03A
	LM79L12ACZ	320L79L12	1800 Units Per Box	
	LM79L15ACZ	320L79L15	1800 Units Per Box	
6-Bump micro SMD	LM79L15ACTL	XTPB	250 Units Tape and Reel	TLA06AMA
	LM79L05ACTLX		3k Units Tape and Reel	

Absolute Maximum Ratings (Note 1)

If Military/Aerospace specified devices are required, please contact the National Semiconductor Sales Office/Distributors for availability and specifications.

Input Voltage

$$V_O = -5V, -12V, -15V \quad -35V$$

Internal Power Dissipation (Note 2) Internally Limited

Operating Temperature Range

$$0^{\circ}\text{C to } +70^{\circ}\text{C}$$

Maximum Junction Temperature

$$+125^{\circ}\text{C}$$

Storage Temperature Range

$$-55^{\circ}\text{C to } +150^{\circ}\text{C}$$

Lead Temperature

(Soldering, 10 sec.)

$$260^{\circ}\text{C}$$

Electrical Characteristics (Note 3)
 $T_A = 0^{\circ}\text{C to } +70^{\circ}\text{C}$ unless otherwise noted.

Output Voltage			-5V			-12V			-15V			Units
Input Voltage (unless otherwise noted)			-10V			-17V			-20V			
Symbol	Parameter	Conditions	Min	Typ	Max	Min	Typ	Max	Min	Typ	Max	
V_O	Output Voltage	$T_J = 25^{\circ}\text{C}, I_O = 100\text{mA}$	-5.2	-5	-4.8	-12.5	-12	-11.5	-15.6	-15	-14.4	V
		$1\text{mA} \leq I_O \leq 100\text{mA}$	-5.25		-4.75	-12.6		-11.4	-15.75		-14.25	
		$V_{\text{MIN}} \leq V_{\text{IN}} \leq V_{\text{MAX}}$	(-20 $\leq V_{\text{IN}} \leq -7.5$)			(-27 $\leq V_{\text{IN}} \leq -14.8$)			(-30 $\leq V_{\text{IN}} \leq -18$)			
		$1\text{mA} \leq I_O \leq 40\text{mA}$	-5.25		-4.75	-12.6		-11.4	-15.75		-14.25	
		$V_{\text{MIN}} \leq V_{\text{IN}} \leq V_{\text{MAX}}$	(-20 $\leq V_{\text{IN}} \leq -7$)			(-27 $\leq V_{\text{IN}} \leq -14.5$)			(-30 $\leq V_{\text{IN}} \leq -17.5$)			
ΔV_O	Line Regulation	$T_J = 25^{\circ}\text{C}, I_O = 100\text{mA}$			60			45			45	mV
		$V_{\text{MIN}} \leq V_{\text{IN}} \leq V_{\text{MAX}}$	(-20 $\leq V_{\text{IN}} \leq -7.3$)			(-27 $\leq V_{\text{IN}} \leq -14.6$)			(-30 $\leq V_{\text{IN}} \leq -17.7$)			V
		$T_J = 25^{\circ}\text{C}, I_O = 40\text{mA}$			60			45			45	mV
		$V_{\text{MIN}} \leq V_{\text{IN}} \leq V_{\text{MAX}}$	(-20 $\leq V_{\text{IN}} \leq -7$)			(-27 $\leq V_{\text{IN}} \leq -14.5$)			(-30 $\leq V_{\text{IN}} \leq -17.5$)			V
ΔV_O	Load Regulation	$T_J = 25^{\circ}\text{C}$			50			100			125	mV
		$1\text{mA} \leq I_O \leq 100\text{mA}$										
ΔV_O	Long Term Stability	$I_O = 100\text{mA}$		20			48			60		mV/khrs
I_Q	Quiescent Current	$I_O = 100\text{mA}$		2	6		2	6		2	6	mA
ΔI_Q	Quiescent Current Change	$1\text{mA} \leq I_O \leq 100\text{mA}$			0.3			0.3			0.3	
		$1\text{mA} \leq I_O \leq 40\text{mA}$			0.1		0.1			0.1	mA	
		$I_O = 100\text{mA}$			0.25		0.25		0.25		0.25	mA
		$V_{\text{MIN}} \leq V_{\text{IN}} \leq V_{\text{MAX}}$	(-20 $\leq V_{\text{IN}} \leq -7.5$)			(-27 $\leq V_{\text{IN}} \leq -14.8$)			(-30 $\leq V_{\text{IN}} \leq -18$)			V
V_n	Output Noise Voltage	$T_J = 25^{\circ}\text{C}, I_O = 100\text{mA}$		40			96			120		μV
		$f = 10\text{Hz} - 10\text{kHz}$										
$\frac{\Delta V_{\text{IN}}}{\Delta V_O}$	Ripple Rejection	$T_J = 25^{\circ}\text{C}, I_O = 100\text{mA}$ $f = 120\text{Hz}$	50			52			50			dB
	Input Voltage Required to Maintain Line Regulation	$T_J = 25^{\circ}\text{C}, I_O = 100\text{mA}$			-7.3			-14.6			-17.7	V
		$I_O = 40\text{mA}$			-7.0			-14.5			-17.5	V

Note 1: Absolute Maximum Ratings indicate limits beyond which damage to the device may occur. Operating Ratings indicate conditions for which the device is functional, but do not guarantee specific performance limits.

Note 2: Thermal resistance of Z package is 60°C/W θ_{JC} , 232°C/W θ_{JA} at still air, and 88°C/W at 400 ft/min of air. The M package θ_{JA} is 180°C/W in still air. The maximum junction temperature shall not exceed 125°C on electrical parameters.

Note 3: To ensure constant junction temperature, low duty cycle pulse testing is used.

Physical Dimensions inches (millimeters) unless otherwise noted

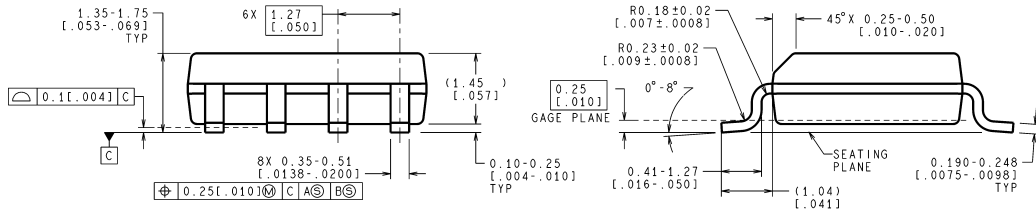
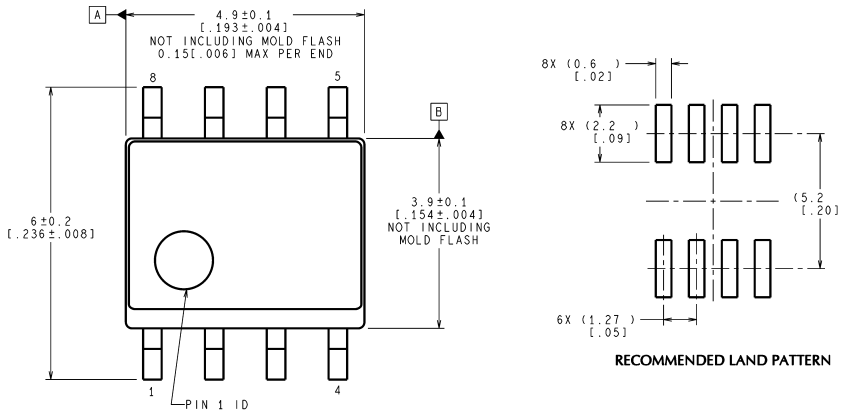

CONTROLLING DIMENSION IS MILLIMETER
VALUES IN [] ARE INCHES
DIMENSIONS IN () FOR REFERENCE ONLY

M08A (Rev K)

SOIC Package (M)
NS Package Number M08A

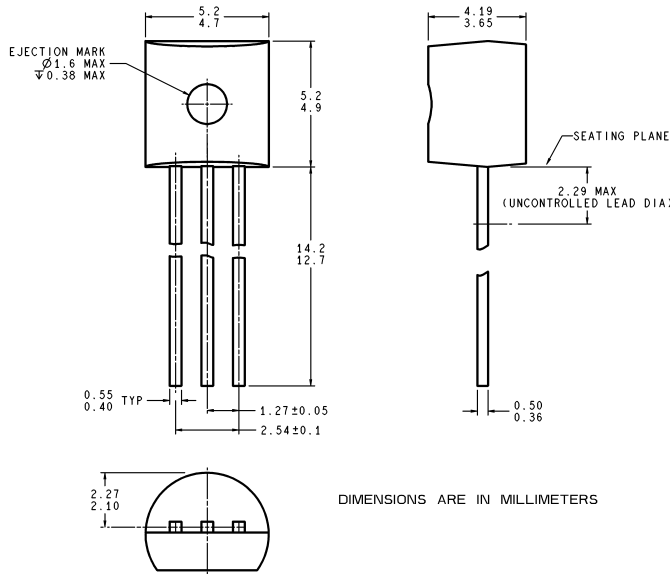

Molded Offset TO-92 (Z)
NS Package Number Z03A

Z03A (Rev G)